

MiniGlobe™



Input Voltage	12V AC
Wattage	3.7W
Nominal Lumens	270lm
CCT	3000K - 1800K
CRI/R9	96+, 80+
Color Fidelity (Rf), Gamut (Rg)	93, 102
Percent Flicker	<3%
Dimming	Phase Dimmable
Dimming Range	100% - <0.1%
Beam Angle	320°



RoHS



SunLight2[®] Bi-pin bulbs are an ultra-compact 12V LED bulb designed for decorative and architectural lighting applications where a small, unique omni-directional LED bulb is essential. It is packed with features that ensure the perfect illumination!

FEATURES

- **Dim to Warm Technology:** 3000K - 1800K CCT
- **Omni-Directional Design:** 320° beam angle
- **Ultra-Compact Size:** 1.6" tall and 1.2" wide
- **High Output Efficiency:** Operating at 3.7W it delivers 270lm
- **Fully Dimmable:** Works seamlessly with standard dimmers
- **Exceptional Color Accuracy:** CRI 96+, R9 80+ and TM30 100
- **No Visible Flicker:** Exceeds Title 24, JA8, IEEE requirements

APPLICATIONS

- **Decorative Lighting:** Glass pendants, wall sconces and chandeliers
- **Hospitality & Hotels:** Set the perfect mood with warm, inviting lighting
- **Residential Lighting:** Enhance chandeliers, sconces, and decorative fixtures with soft, adjustable illumination
- **Architectural & Accent Lighting:** Elevate interior designs with high-quality, energy-efficient LED lighting
- **Museum & Art Galleries:** Using patented technology engineered for superior color accuracy

MODEL SPECIFICATIONS

Model Number	Lens Shape	Watts	Input Voltage	CCT	Lumens	Beam Angle	Finishes
G44W12V3018KWD120W-1	Globe	3.7W	12V AC	3000K dims to 1800K	270lm	320°	White
G5.34W12V3018KWD120W-1	Globe	3.7W	12V AC		270lm	320°	White

Custom Finishes & CCT Available

RECOMMENDED POWER SUPPLIES

Model Number	Wattage	Input	Output	IP Rating	Dimming
TA60WA12LED	60W	120V AC, 0.5A 50/60Hz	12V AC	IP60	ELV Type
TA60WA12LED65B15				IP65	
TE60WA12LED65B15		277V AC, 0.2A 50/60Hz	12V AC	IP65	

SPECTRORADIOMETRIC CHART

3000K

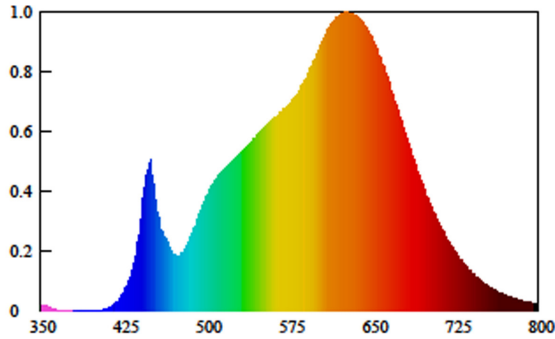

1800K

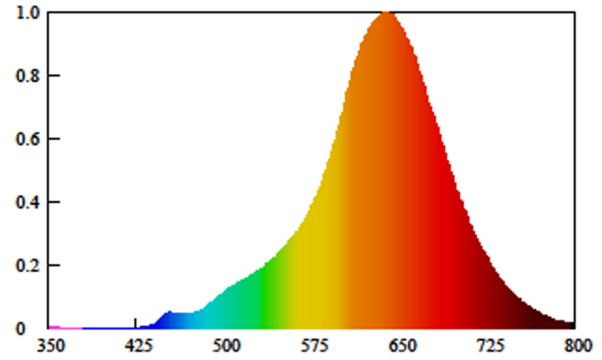

CRI TEST

3000K

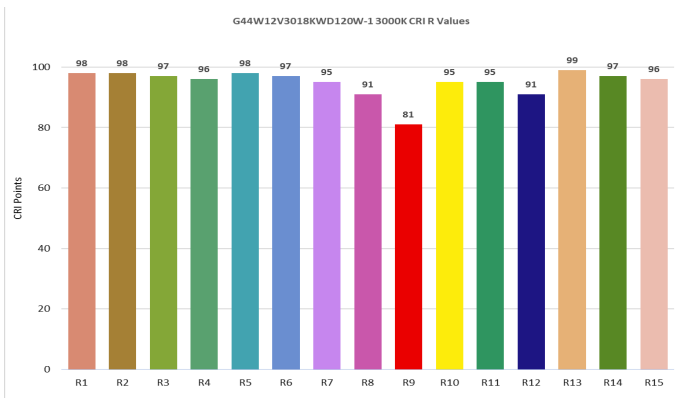

1800K

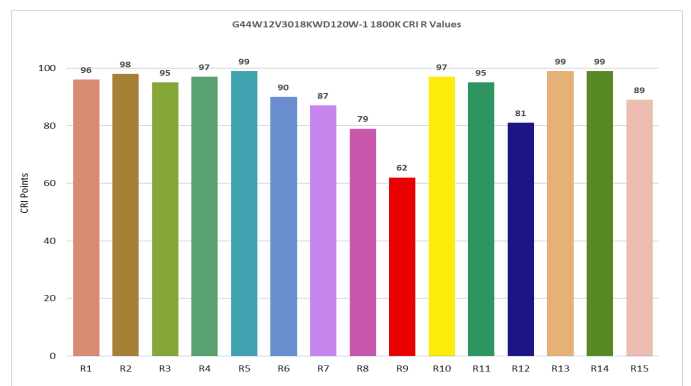

TM30 TEST

3000K

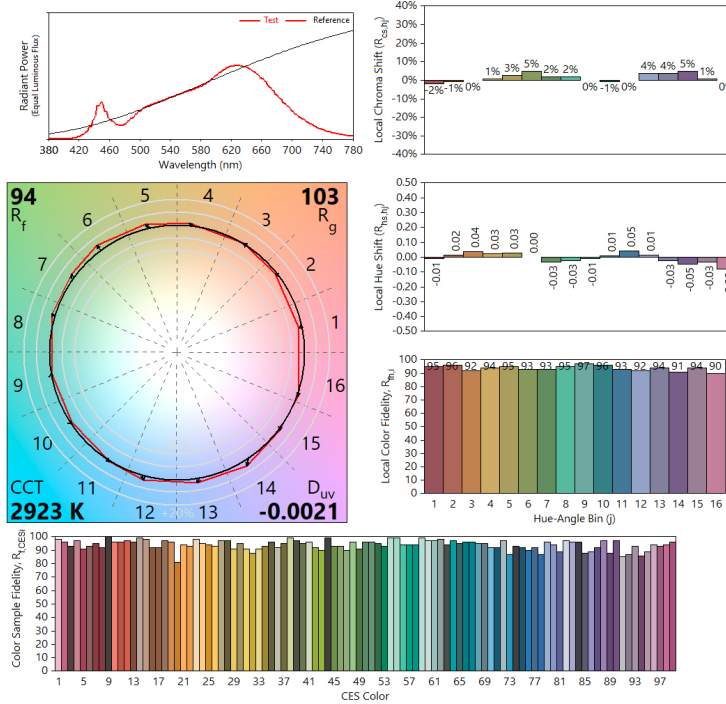

1800K

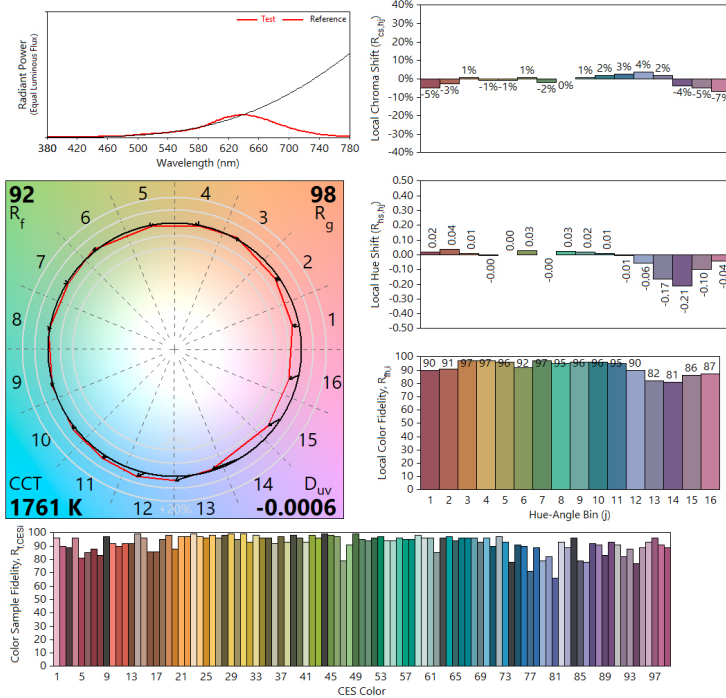

DIMMING CURVE

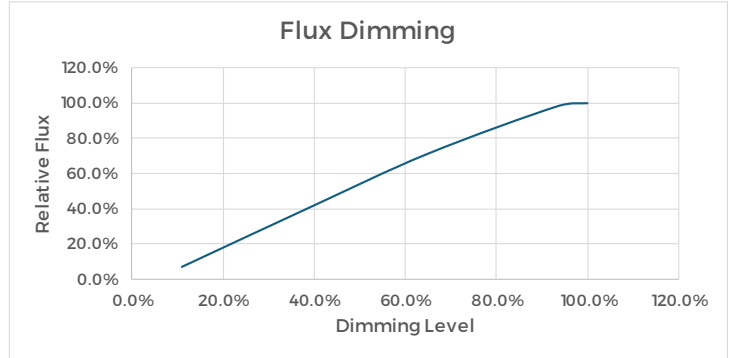
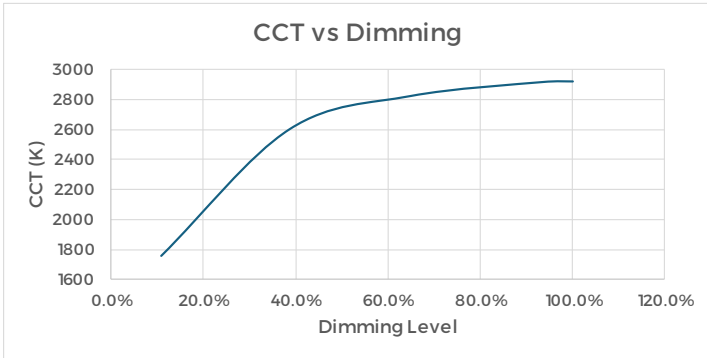

MECHANICAL SPECIFICATIONS

G4 (MiniGlobe)

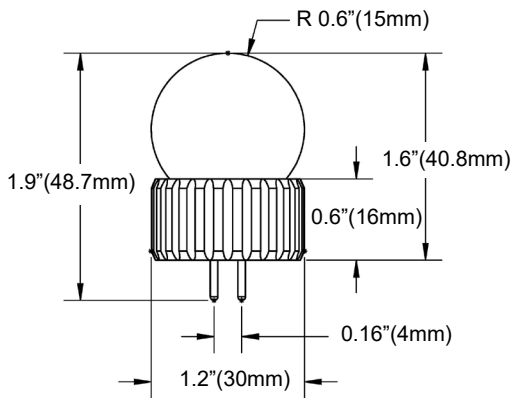

G5.3 (MiniGlobe)

